

DKF

DİKDÖRTGEN KANAL TİPİ RADYAL FANLAR

RECTANGULAR IN-LINE RADIAL FANS



- 500 m³/h – 10,500 m³/h hava debisi aralığında çalışmaktadır.
- Gövde galvaniz sacdan imal edilmiştir.
- Fanlarımızda dıştan rotorlu motor kullanılmıştır.
- Pervaneler seyrek kanatlı olup galvaniz sacdan imal edilmiştir. Dinamik balansları alınmıştır.
- Kanala kolay bağlanabilme özelliğine sahiptir.
- Opsiyonel olarak hız kontrol cihazı ile hava debisi ve basınç ayarlanabilir.
- Yalıtım : class B
- Koruma sınıfı : IP 44

Kullanım alanları : Proje bazlı çalışmalar (Alışveriş Merkezleri, Hastane, Üniversiteler, Fabrikalar, Oteller) ile endüstriyel mekanların havalandırılmasında kullanılabilir.

- Has air flow between 500 m³/h and 10,500 m³/h.
- Impellers are backward curved and made from galvanized sheet metal.
- Casing is made from galvanized sheet metal.
- It is easy to be mounted to the duct.
- As an option, a speed control device can be used to adjust the air flow and pressure.
- Insulation : class B
- Protection : IP 44

Application Areas: Can be used for ventilation in the project-based works like malls, hospitals, universities, factories, hotels and other industrial places.

16

TEKNİK TABLO / TECHNICAL PARAMETERS

Tip Type	Voltaj Voltage	Frekans Frequency	Güç Power	Akım Current	Kondansatör Capacitor	Devir Speed	Debi Air Flow	Ses Seviyesi Sound Pressure Level	Ağırlık Weight
	V	Hz	W	A	(µF/Volt)	d/d	m ³ /h	dB(A)	Kg
DKF-30/15-2K-M	220	50	90	0,35	2,5/400	2650	500	47	8,00
DKF-40/20A-2K-M	220	50	105	0,47	4/400	2750	950	54	12,00
DKF-40/20B-2K-M	220	50	140	0,60	5/400	2690	1215	57	13,50
DKF-50/25-2K-M	220	50	215	1,00	6/400	2550	1850	51	16,00
DKF-60/30-4K-M	220	50	130	0,60	4/400	1400	2000	50	17,00
DKF-60/35A-4K-M	220	50	200	0,90	6/400	1390	2750	54	35,00
DKF-60/35B-4K-M	220	50	400	1,90	8/400	1370	3350	57	38,00
DKF-70/40A-4K-M	220	50	600	2,70	14/400	1315	4500	59	43,00
DKF-70/40B-4K-M	220	50	680	3,00	18/400	1380	5800	61	46,00
DKF-80/50-4K-T	380	50	880	1,70	-	1375	8200	64	64,00
DKF-100/50-4K-T	380	50	1450	2,60	-	1365	10500	67	92,00

*Ses seviyesi 3m mesafeden ölçülmüştür. / Sound levels has measured at a distance of 3 meters.

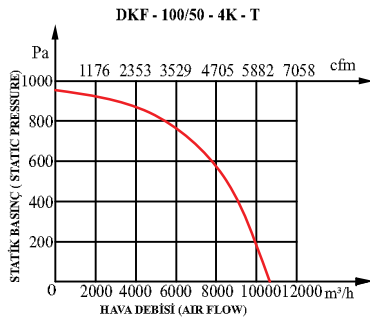
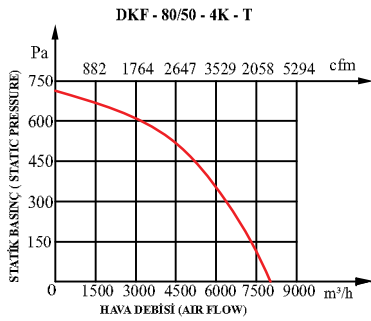
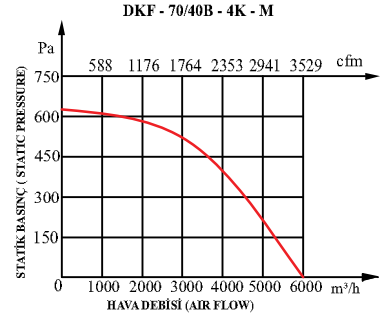
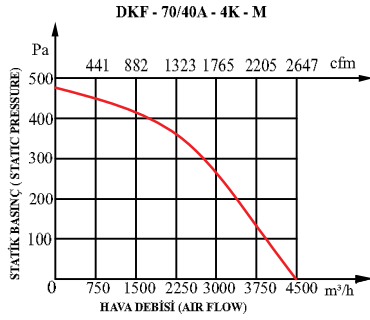
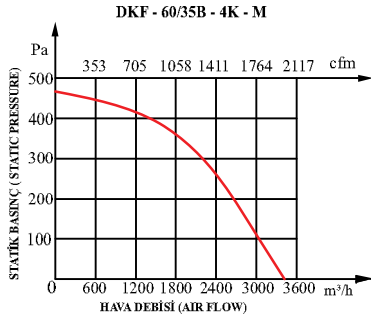
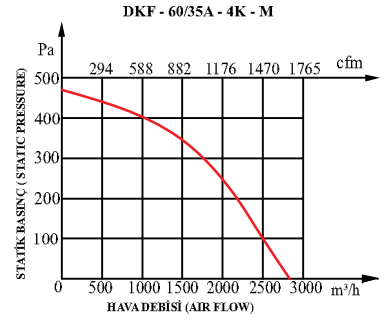
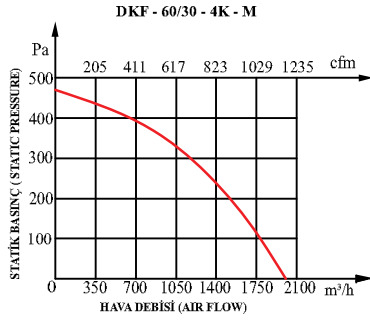
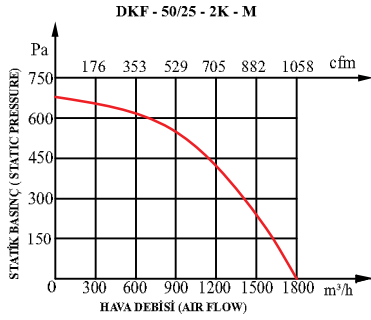
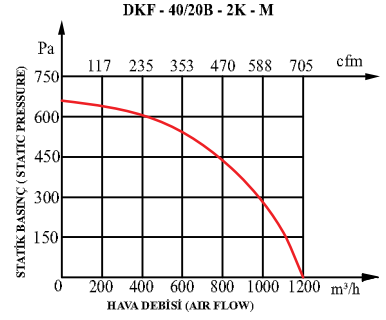
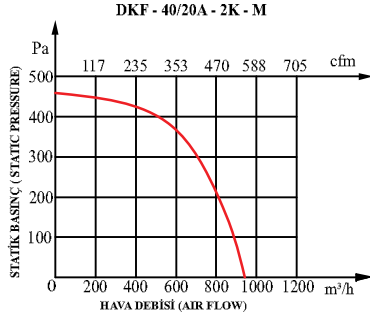
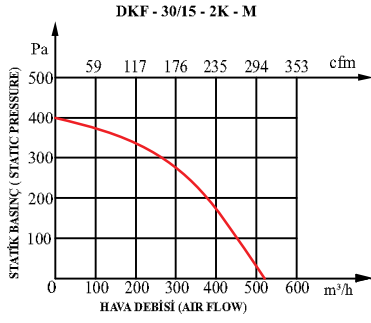

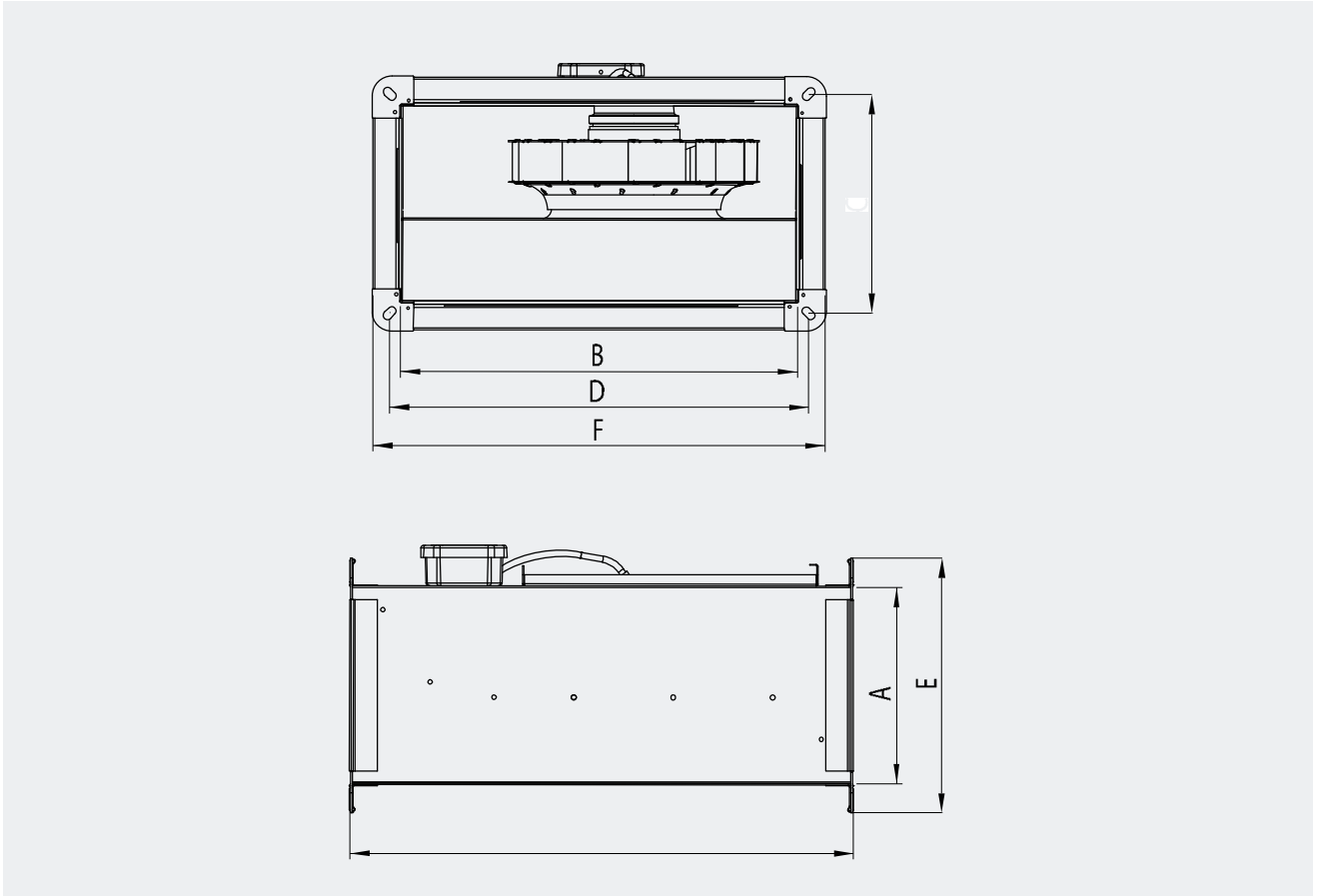
TEKNİK ÇİZİM VE ÖLÇÜLER / TECHNICAL DRAWINGS AND DIMENSIONS

18

Tip /Type	A	B	C	D	E	F
DKF-30/15-2K-M	150	300	400	320	170	350
DKF-40/20A-2K-M	200	400	500	420	220	450
DKF-40/20B-2K-M	200	400	500	420	220	450
DKF-50/25-2K-M	250	500	565	520	270	550
DKF-60/30-4K-M	300	600	650	620	320	650
DKF-60/35A-4K-M	350	600	760	620	370	650
DKF-60/35B-4K-M	350	600	760	620	370	650
DKF-70/40A-4K-M	400	700	800	720	420	750
DKF-70/40B-4K-M	400	700	800	720	420	750
DKF-80/50-4K-T	500	800	920	820	520	850
DKF-100/50-4K-T	500	1000	1050	1030	530	1060

*Ölçüler mm cinsindedir. / Dimensions are in (mm)

AKSESUARLAR / ACCESSORIES

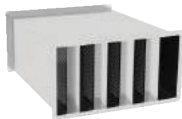
MHA

DHA

DKS

* Bu ürünler ile ilgili detaylı bilgiyi Aksesuarlar bölümünde bulabilirsiniz.
You can see the details of these products in Accessories section.